

		Materiaal:	Aantal:
		Sheet nr.: 2	
		Amerikaanse projectie:	Artikelnummer:
			<b>JAC<sup>2</sup>06STFR</b>
Tekenaar: Rudolf	Getekend: 4-4-2022	<b>JACOBUS 6, kwadraat, front, stand.</b> <b>Hoogte tafel aanpasbaar (maatwerk)</b>	
Controle: -	Gecontroleerd:		
Schaal: 1 : 10	Maateenheid: Milimeters		
Status: WorkInProgress			
Janco de Jong BV, Tolbaas 2-10, 8401GD Gorredijk. T 0513 571757, E. info@jancodejong.nl, www.jancodejong.nl			Revisie:  Formaat: <b>A4</b>

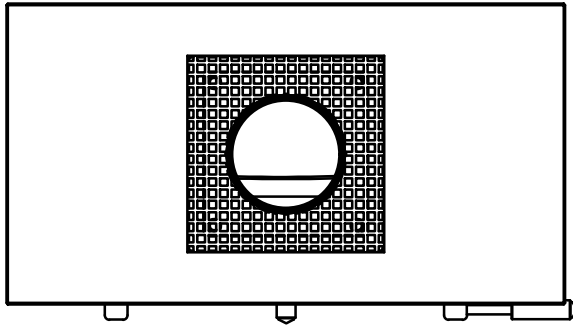

Ø150 (standaard)  
Ø130 (optie)

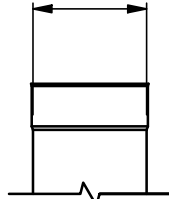

739

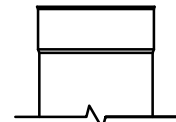
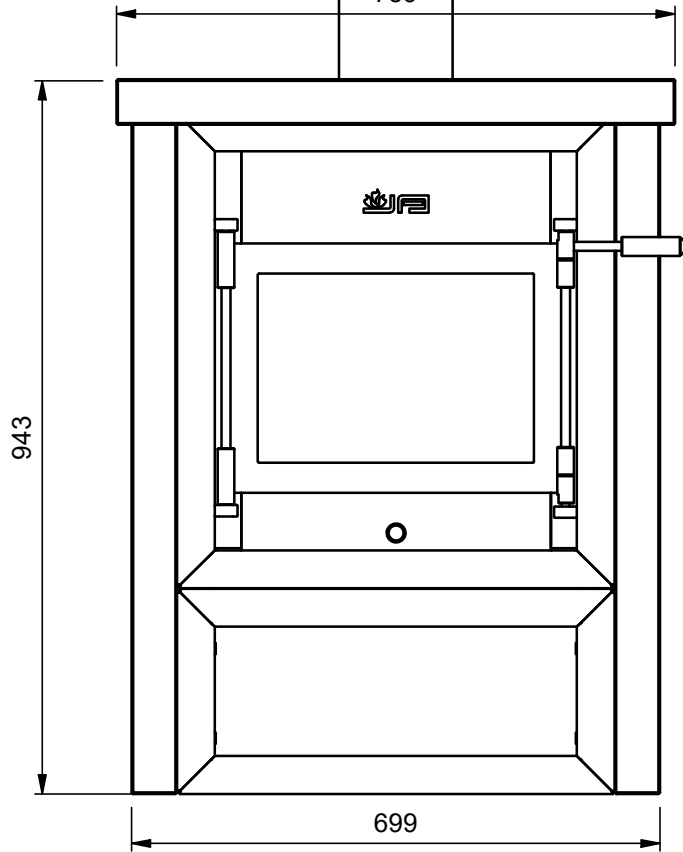

398

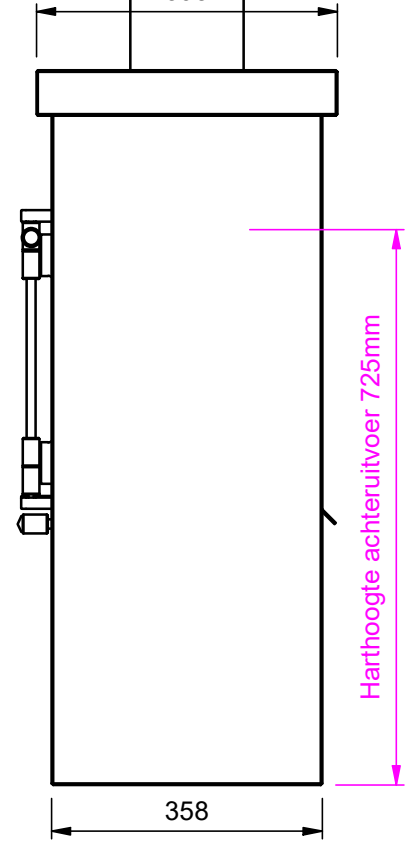

Materiaal:

Aantal:

Sheet nr.: 12

Amerikaanse projectie:

Artikelnummer:

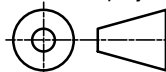

Kachel: JAC<sup>2</sup>09STFR

Betonset: JAC<sup>2</sup>09BALSA02

Tekenaar: Rudolf

Getekend: 4-4-2022

Controle: -

Gecontroleerd:

Schaal: 1 : 10

Maateenheid: Milimeters

Status: WorkInProgress

Jacobus 9, kwadraat, front,  
stand, BETON

Revisie:

Formaat:

A4

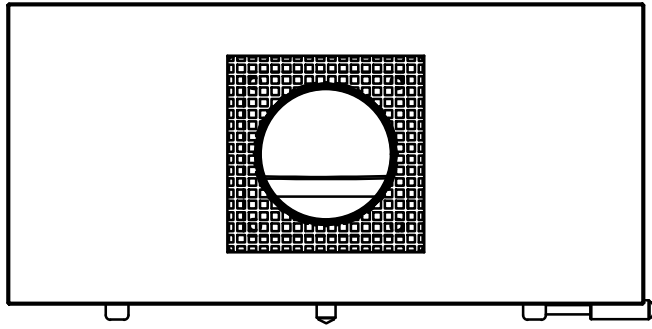

Ø180 (standaard)  
Ø150 (optie)

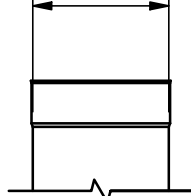

842



398

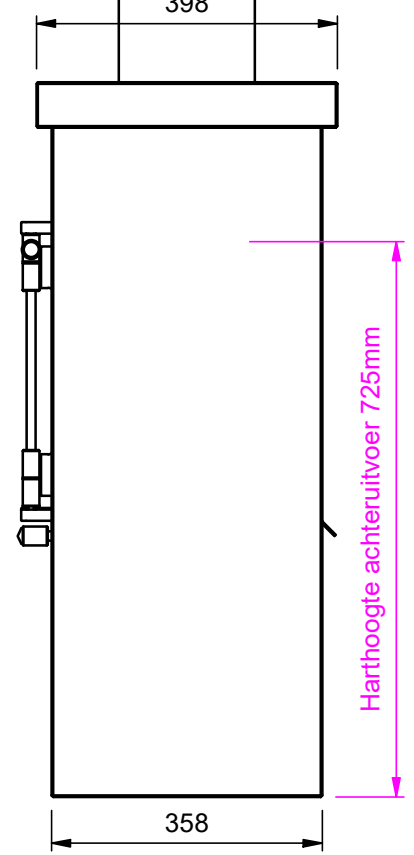
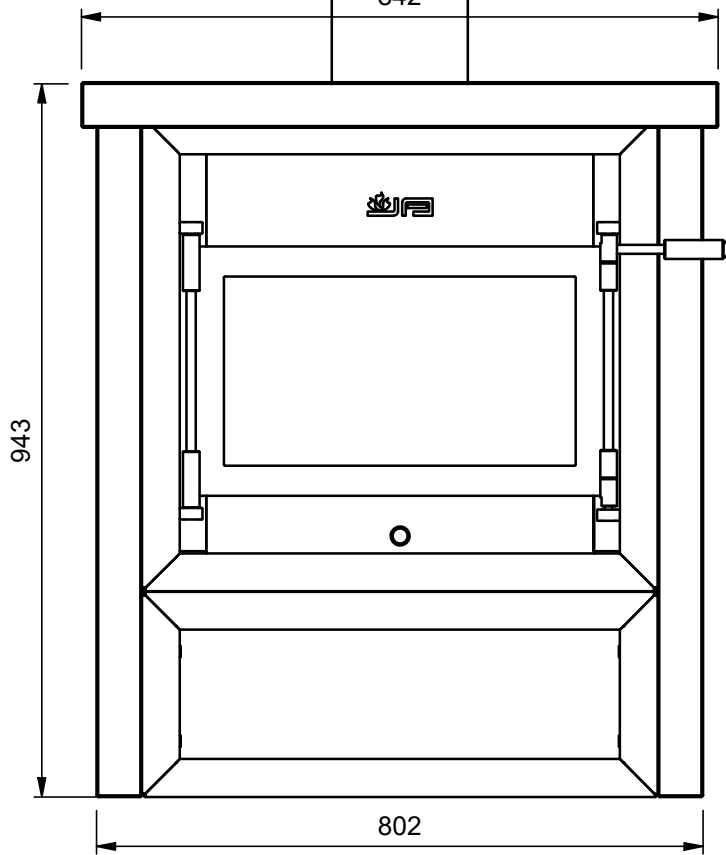

Materiaal:

Aantal:

Sheet nr.: 20

Amerikaanse projectie:

Artikelnummer:

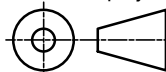

Kachel: JAC<sup>2</sup>12STFR

Betonset: JAC<sup>2</sup>12BALSA02

Tekenaar: Rudolf

Getekend: 4-4-2022

Controle: -

Gecontroleerd:

Schaal: 1 : 10

Maateenheid: Milimeters

Status: WorkInProgress

Jacobus 12, kwadraat, front,  
stand, BETON

Revisie:

Formaat:

A4